



User manual



VeloPlus3

Van Raam
Guldenweg 23
7051 HT Varsseveld, The Netherlands

☎ +31 (0)315 – 25 73 70

✉ info@vanraam.com

🌐 www.vanraam.com

Version 24.10



Table of contents

Manufacturer contact details	3
Conformity.....	3
Introduction.....	4
Delivery.....	4
Indication.....	5
Intended usage	5
Safety measures.....	6
Adjustment of the tricycle.....	8
Before the first use.....	13
Silent electrical system	20
Silent Electrical System options	33
Van Raam e-bike app.....	34
Accessories.....	35
Technical specifications	41
Maintenance and adjustments to be done by owner.....	42
Repairs and maintenance to be done by dealer	43
Adjustments by dealer	44
Disposal	45
Handover/sale to a new owner	45
Guarantee	46
Frame number.....	47
Maintenance recommendation	48
Service plan.....	50
Delivery and service form.....	55

Manufacturer contact details

Van Raam

Guldenweg 23

7051 HT Varsseveld, The Netherlands

☎ +31 (0)315 – 25 73 70

✉ info@vanraam.com

🌐 www.vanraam.com

Conformity

Conformity Europe (CE)

Van Raam Reha Bikes B.V., as manufacturer, declares that the VeloPlus3 as described in this user manual is manufactured in accordance with Regulation (EU) 2017/745, risk class 1. The VeloPlus3 supplied with the Silent electrical system also complies with Directive 2006/42/EC including the applicable parts of EMC Directive 2014/30/EU and the NEN-EN 15194:2017 Bicycles - Electric supporting bicycles - EPAC Bicycles - part 4.2 Electrical requirements. The signed declaration of conformity can be found on the Van Raam website.

Conformity UK (UKCA)

Van Raam Reha Bikes B.V. as manufacturer declares that the VeloPlus3, as described in this user manual, is manufactured in accordance with the "Essential Requirements of Medical Devices Regulation 2002" (UK MDR 2002 Class 1 Medical Devices). The VeloPlus3 supplied with the Silent electrical system also complies with the "Machinery (Safety) Directive SI 2008/1597" including the applicable parts of "Electro Magnetic Compatibility Regulations SI 2016/1091" and the NEN-EN 15194:2017 Bicycles - Electric support bicycles - EPAC Bicycles - part 4.2 Electrical requirements. The VeloPlus3 is provided with UKCA label according to "EU Exit Regulations 2020/1478". The signed declaration of conformity can be found on the Van Raam website.

Introduction

This user manual provides important and necessary information about the use of your tricycle. We ask you to read this manual thoroughly before using the tricycle. Always follow the instructions as provided in this user manual and keep the manual carefully. The most current version of the user manual can be found on the product page of the bicycle on the website www.vanraam.com.



READ CAREFULLY

Delivery

The delivery should include the following:

- Tricycle with packaging
- User manual(s)
- Possible Smart-battery including card with 5-digit code (depending on options)
- Possible chargers (depending on options)
- (Spare) keys

Check the delivery immediately after receiving it. In case of damage or incomplete delivery we ask you to contact your dealer immediately. Upon delivery you should fill out the form "Form service, maintenance, modifications and warranty claims" in the back of this manual.

Indication

The VeloPlus3 is intended for cycling with children or adults who are in a wheelchair and transfer is not possible or difficult.

Intended usage

The tricycle is designed for normal use on level and solid ground. In general, tricycle caution should always be observed when using the tricycle. Moreover, the safety instructions as described in this manual should be explicitly followed. Local traffic laws and regulations should also be observed.

The tricycle is meant for two persons, one driver and one passenger in his/her own wheelchair. The rider must be independently mobile and may not have any serious visual or other restrictions which prevent responsible participation in traffic. The maximum weight of the rider, passenger and luggage rack load (to be found in the chapter '**Technical specifications**') may not be exceeded.

Before using the bicycle, please read the safety instructions to ensure your wheelchair is suitable for use.

The manufacturer is not responsible for any damage or injury caused as a result of or during the course of any other type of use.

Safety measures

- Ensure the tricycle is in good condition each time before using it. Check before **each** ride that the brakes are in order. Check the lighting and make sure there is enough tyre pressure.
- Regularly check if the wheels, the handlebars and the saddle are properly fixed and also whether all screw joints are tight.
- Only use the tricycle on a **solid and level surface**.
- It is not recommended to cycle on a slope steeper than 10%, this carries an increased risk.
- Always drive perpendicularly and at low speed off the curb or speed bump.
- Make sure that wide trousers or loose hanging clothing don't get caught in the chain, spokes or pedals.
- Do not use a pressure washer or a steam cleaner for the cleaning of the tricycle.
- Block the tricycle to stop it from moving when you are getting on or off the tricycle. Do this by using the parking brake and holding the tricycle. Also use the parking brake if the wheelchair is driven on or off the ramp.
- Always lock the tricycle when leaving it unattended.
- **Never** drive without a passenger. This will cause instability of the bike and will lead to dangerous situations.
- **Never** place your feet or other limbs under the ramp. You can be hit by moving parts and suffer from bruises.
- **Always** place the wheelchair forward, in the driving direction, on the ramp.
- Your wheelchair is suitable for use when the centre of gravity can be placed above the front wheels of the bicycle and when it can be fixed according to the instructions under the heading 'wheelchair transport'.
- Make sure that once the wheelchair is placed on the ramp, the wheelchair's weight causes the ramp to fold up automatically. When that is the case, the centre of gravity of the wheelchair is situated above the front wheels of the bicycle. This creates the correct weight distribution of the bicycle.
- Extra attention is required for an electric wheelchairs because these often have different weight distributions as a result of which the centre of gravity may not be positioned correctly.
- Make sure that you do not reach a dangerous speed when driving downhill and entering tunnels. Brake in time and bike at a moderate speed.
- In case of pregnancy, extra care is required owing to a higher risk of injury.

- Do not leave the tricycle in direct sunlight: the temperature of some parts could exceed 41°C resulting in possible burns to the skin.
- If your tricycle is equipped with the Silent electric motor system, make sure that you get used to riding with the electric support engaged. Be careful when you turn on the electric support system and make sure you don't get startled by unexpected behaviour because you turned on the electric support.

Load

The maximum load should not be exceeded. See the information in the technical data table in the **'Technical Specifications'** section of the user manual. By permitted load we mean the total load, including the load on the luggage rack and the wheelchair.

Make sure that the permitted load on the luggage rack is not exceeded. (**maximum 20 kg**). People may not be transported on the luggage rack!

Damaged or worn out parts

The replacement and repair of parts (frame, forks, light, brakes, drive mechanism and the handlebars) should **always** be performed by an authorised dealer. If not, the guarantee ceases to be valid and you will be personally responsible in the event of possible damage.



Specific safety parts should **always** be replaced by new parts!

Adjustment of the tricycle

Before using the tricycle, adjust it to the measurements of the cyclist. This is of great importance, especially the saddle and the handlebars.



If an optimal adjustment of the tricycle, as defined in the instructions, is not possible, you can contact your dealer for a fitting solution.

The brakes are correctly adjusted and should only be adjusted by the dealer during periodic maintenance.



Take care that fingers and limbs do not get trapped while adjusting the tricycle.

Saddle height

When the cyclist is sitting on the tricycle and can put a foot on the pedal in the lowest position, the saddle height is correct. Adjust the saddle height in such a way that the leg is stretched but relaxed in that position.

To adjust the saddle:

1. Open the quick-clamp [A].
2. Slide the saddle to the correct height.
3. Close the quick-clamp.

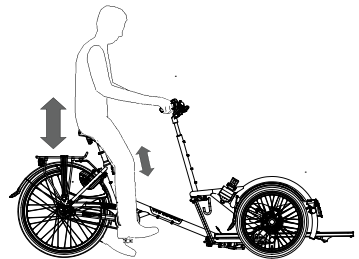

Make sure clothing cannot get caught in the clamp!



If the clamp closes too easily, the clamping force is too low. In this case, open the clamp and tighten the nut [B] a bit more. If a lot of force is necessary to close the clamp, the nut should be loosened slightly.

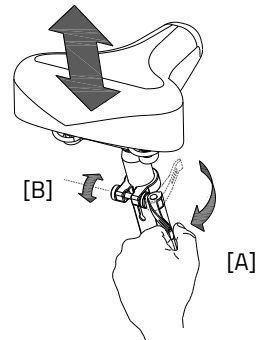



Don't **pull out** the seat post further than the markings. If you do so, the tube won't be inserted deep enough into the shaft, increasing the risk of breakage, which may lead to serious injuries.



Handlebars height

The height of the handlebars affects the comfort of the ride. It determines the pressure on the hands and the position of the back. You decide the most comfortable position yourself with some practice.

To adjust the handlebars:

1. Slightly loosen the screw by using an Allen key.
2. Slide the handlebars to the correct height and tighten the screw very firmly again.

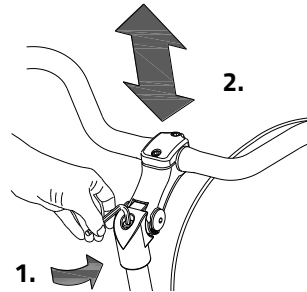

Do **not** pull out the handlebars **further** than the mark. Otherwise the tube will not be deep enough in the shaft and will risk coming off, which can lead to serious injuries.



Position handlebars

You can tilt the handlebars. This influences the distance from the handlebar to the upper body. Determine your own most comfortable position by using the bike.

To tilt the handlebar:

1. Slightly loosen the screws [A] and [B] with an Allen key.
2. Put the handlebar in the desired position and then tighten the screws considerably.
3. Slightly loosen screw [C] with an Allen key, put the handlebar in the correct (horizontal) position and then tighten the screw again.

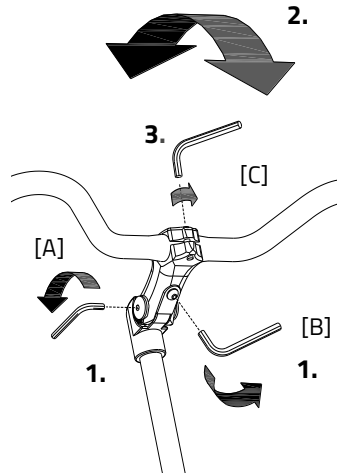

Steering damper

The steering damper affects the stability during steering. By adjusting the screw, steering gets more rigid and stability will increase. Determine your own most comfortable setting for using the bike.

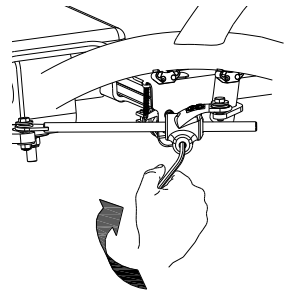

Wheelchair transport

If you want to transport a wheelchair on the VeloPlus3, follow the instructions below.

1. Attach the parking brake to the bike by squeezing the left brake [A] and lock it with the pin [B].
2. Remove the safety pin.
3. Pull the handle up so the ramp unlocks and falls down.
4. Push the wheelchair backwards on the ramp. Push the wheelchair until the ramp is tilting and locks itself automatically with a clear noticeable click.
5. Attach the wheelchair with the three belts. Push the button to release the belt and attach the hooks to the wheelchair.

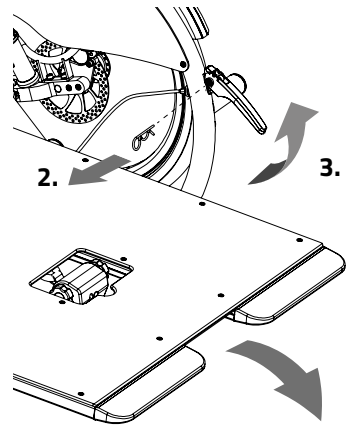
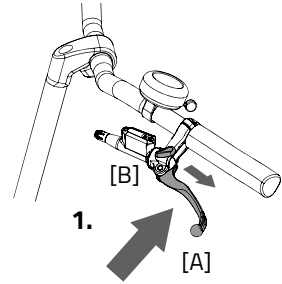

Always place the wheelchair forward, in the driving direction, on the ramp. (see image)



Be sure that the ramp is locking! Failing to do so may result in serious injuries. If the ramp does not lock properly then use your foot [A] to push until the ramp locks.

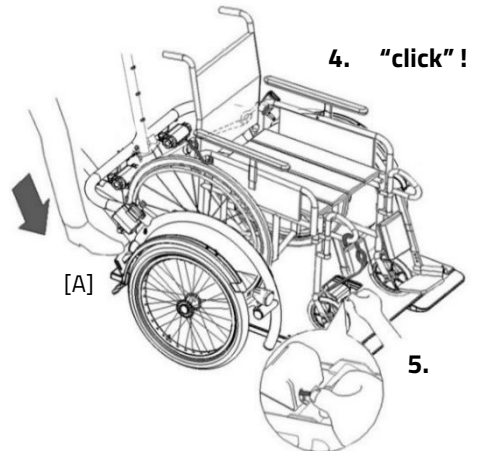



Make sure that once the wheelchair is placed on the ramp, the wheelchair's weight causes the ramp to fold up automatically. When that is the case, the centre of gravity of the wheelchair is situated above the front wheels of the bicycle. This creates the correct weight distribution of the bicycle.

6. Next, turn the star knob to tighten the belts.
7. Finally fasten the safety belt of the passenger.
8. Replace the safety pin in the coupling.

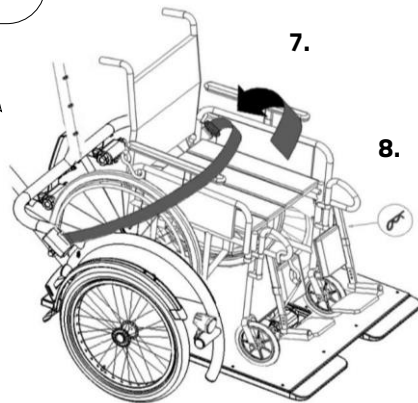
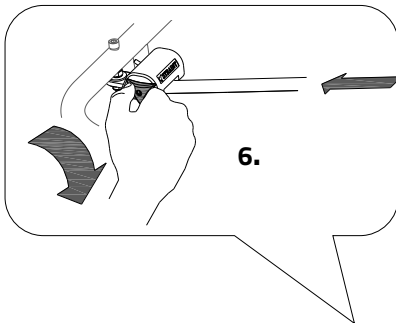

To remove the wheelchair from the bike, follow these steps in reverse order.



Caution: Stop the wheelchair when you release the hooks so that it will not roll off the ramp.

Before the first use



Remove foil

Remove the protective foil from the plate before using the bicycle.

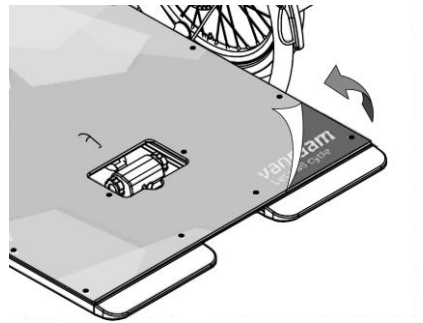

Parking brake

Always use the parking brake if you park the tricycle and leave it behind.

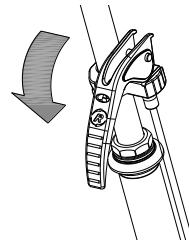

Block the tricycle with the hydro brake when passengers are getting on and off.

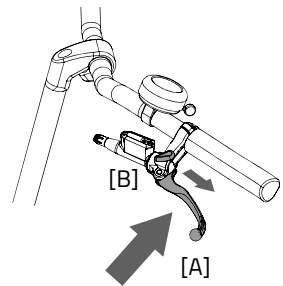

To operate the parking brake, squeeze the left brake [A] and secure the brake with the lever [B].



Always try to park the tricycle on a level surface. The tricycle may never be parked on a slope bigger than 6 degrees.

Lighting

Normally, the lighting on your bike can be operated manually and set to different modes. However, if your bike is equipped with the Silent Elektro system, your lighting will automatically turn off when the electric system is activated. The controls of both the manually operated and centrally operated lighting is explained below.

Manually operated headlight

The front light has a pressure switch with three settings: **On/Auto/Off**.

By pressing the pressure switch once, the front light will turn on. By pressing again the lamp will switch to 'Auto' mode (a green LED will flash for 5 minutes). Finally, a third press will turn the front light off.

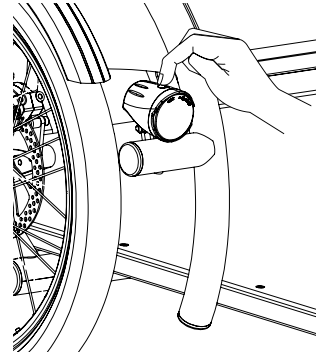

Auto "on" feature:

The front light will automatically turn (as long as it is in 'Auto' mode) on when it is dark, the light sensor is activated and the tricycle is in motion.

Auto "off" feature:

The front light will automatically turn off after 4.5 minutes without motion in 'Auto' mode. The light will first dim from 100% to 50% and then completely turn off.

Adjust the angle of the front light so that the centre of the light beam is located approximately ten metres in front of the tricycle.

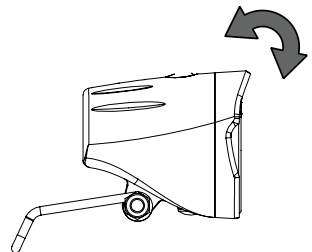

Under the pressure switch on the top of the front light is a battery indicator that lights up when the batteries are low. Once the battery indicator starts lighting up red, replace the batteries as soon as possible.

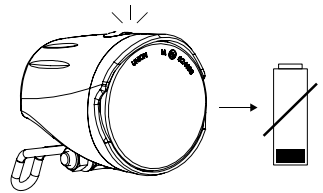

The light comes with 4 pre-installed AAA alkaline batteries. Before use, remove the plastic strip that protects the batteries.

Follows the steps below to replace the batteries.

1. Remove the screw on the bottom of the front light with a screwdriver.

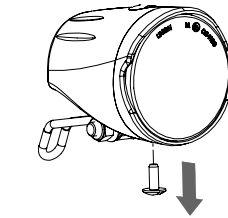

2. Remove the front cover by turning it slightly and pulling it forward.

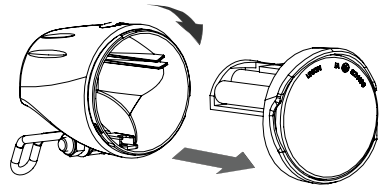

3. Replace the alkaline batteries (1.5 V - 1500 mA) and reattach the front cover.

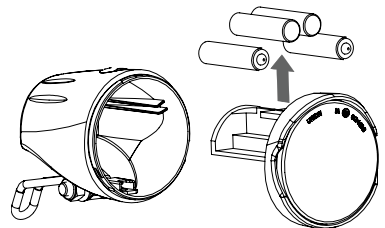

Only operate the lighting when the tricycle is stationary to prevent dangerous situations and risk of crushing. Advice: use the automatic function of the lighting.

Manually operated rear light

The rear light has three options which you can choose by pressing the button repeatedly: **On-Auto-Off**.

The setting is as follows:

- Press **1x**: light is on
- Press **2x**: lighting is automatic
- Press **3x**: light is off

With the "On" or "Off" mode, the rear light can be manually switched on and off. With the "Automatic" mode the rear light automatically turns on and off with the help of light and movement sensors. When the tricycle stands still for a while, the light will automatically turn off.

The rear light works on batteries. When the batteries are almost empty, a red LED light on the top starts flashing. To replace the batteries, follow the next steps.

1. Dismantle the cover of the holder by pressing in the lip at the bottom of the light.
2. Replace the alkaline batteries (1,5 V – 1500 mA) and assemble the cover.



*Batteries cause environmental pollution.
Follow the local regulations during disposal.*

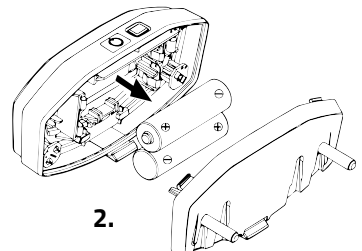
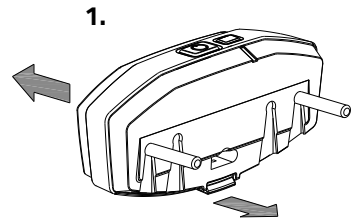
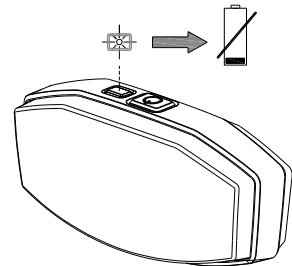
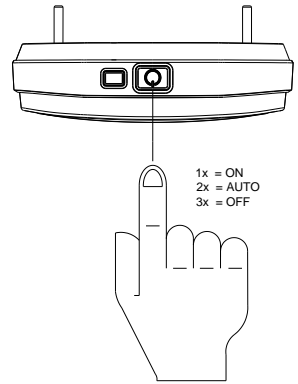

Centrally Operated Lighting

The bike has been equipped with centrally operated lighting, with the lighting being connected to the electric system.

The lighting will turn on automatically when the electric system is activated.

Adjust the angle of the headlight, so that the centre of the light beam is aimed about ten metres in front of the bike.

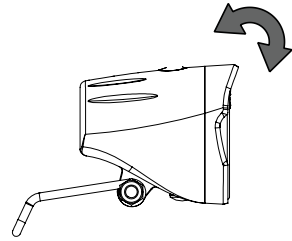

You can manually turn the lighting on and off by briefly pushing the on/off button on the display. When the electric system is turned off, the lighting will turn off automatically.



Make sure there is always a battery on the bike when you are cycling after dark!

Once the battery is nearly empty, the motor will no longer provide pedal support power assistance while cycling. The lighting will still be powered by leftover power.

Gears

Your tricycle has eight gears. The gears can be adjusted by turning the handle. **Never pedal** when changing gears.

Please note: If your bike has an electric motor at the rear, you must **continue pedalling** when changing gears.

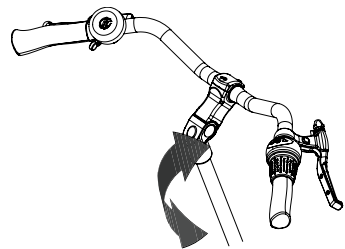

***Please note!** Do not shift gears and then paddle backwards. This could cause the chain to run off the sprocket.*

Check before every ride:

- The brakes (including the parking brakes)
- The tyre pressure (recommended: 3 bar)
- The lights
- That all parts are fitted properly
- That the battery is adequately charged (depends on options)

Contact your dealer and stop using your tricycle as soon as you observe irregularities during the check!

As with all mechanical parts, the tricycle is subject to wear tear and high loading. If a component fails, it can lead to very dangerous situations. This can lead to damage or injuries to the user of the tricycle. Any form of cracks, scratching or change in colour in heavily loaded parts or a component indicates that the component must be replaced.

Points of interest during cycling

After you have adjusted the tricycle to the measurements of the cyclist, you can start using the bike.



The tricycle gives a very different ride experience than a bicycle!

Practice, in particular, with bends and braking, because a tricycle can react contrary to what you would expect. It may happen that the back wheel comes off the ground on the inside when going round a bend. To avoid this, the rider leans towards the inside of the bend with his body.

One of the brake levers (usually the right) operates the brake on the front wheel. This deserves special caution, as a forceful braking could block the front wheel, which could result in a fall. The driver should be familiar with controlled braking of the front wheel!



If there is an electric motor on a bike: you must train with the acceleration function and reverse functions. Be careful that the acceleration mode or reverse mode are not unintentionally started while using the bike. For example, at traffic lights the reverse function can accidentally be activated and the tricycle reverses.



High speeds in the bends, driving on rough ground, and sharp bends can lead to the tricycle **falling over!**



The tricycle will behave differently when cycling without a passenger. Try this very carefully the first time!

Important safety points for the cyclist

- Be very careful during the first ride.
- When riding the tricycle hold both hands firmly on the handlebars and feet on the pedals.
- Test the riding style of the tricycle on rough ground at moderate speed. This way the cyclist learns how to react to unexpected movements of the tricycle and the handlebars during use.
- Explore how the tilting movements of the tricycle react to body posture. Tilt to the inside of the bend.
- Small obstacles should be cycled over with appropriate speed.
- Obstacles higher than five centimetres should be avoided.
- Ensure that no dangerous speed develops while driving downhill and entering tunnels. Brake on time and cycle at a moderate speed.

Silent electrical system

Item number: -2195

The Silent electrical system comprises 5 components: display, button unit, battery, motor and bottom bracket. How the first 3 parts are used is explained in this user manual.

Operation of the display

The display provides you with cycling information, which will be explained in more detail later. The display is mounted onto the handlebars by means of a bracket. The display cannot and does not have to be removed when leaving the bike.

(1) On/off

This button switches the electrical system on.

(2) Bicycle lights

The lights on the bicycle switch on automatically when the electrical system is switched on. By pressing this button briefly, the lights can be switched off (and on).

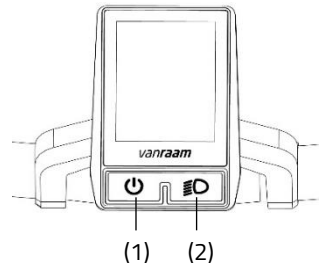

Operation of the button unit

The button unit is mounted next to the handlebar grip. You use the button unit to operate the electrical system.



The button unit can be mounted on the other side of the handlebars by your dealer.

(3) Mode

By pressing this button briefly, you can switch between the different Screen modes.

(4) Plus - Increase pedal support power assistance

(5) Minus - Reduce pedal support power assistance

(6) starting aid

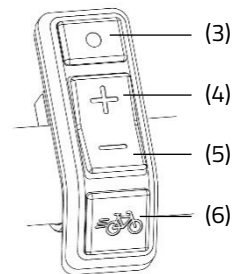

Information screen

After the electrical system is powered up, the information screen is displayed. This screen displays real-time cycling information.



The information screen will only work if you have switched on the electrical system.

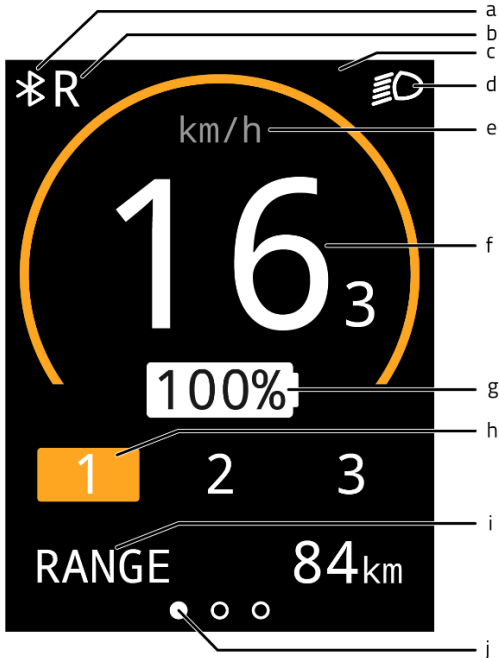

- (a) Bluetooth connection
- (b) Reverse function of (thumb) throttle activated
- (c) Notification field
- (d) Bicycle lights
- (e) Speed indicator
- (f) Speed
- (g) Battery charge percentage
- (h) Assistance mode
- (i) Screen modes
- (j) Screen mode orientation bar

Screen modes

The screen mode (i) can be set by using the mode button (3) You can switch between the following 3 screen modes while cycling.

1. Radius of action [RANGE] (default display)
This is the number of kilometres that can still be cycled with the remaining battery capacity in the active assistance mode.



The range is assistance mode dependent and is an estimate, so the actual range may differ from the estimate. The range is dependent on several factors. Among others, the range is influenced by: battery capacity, amount of assistance, tyre pressure, ride speed, rider weight and load, and the environment.

2. Trip distance [TRIP]
This is the distance travelled since the trip odometer was last reset. By holding down the mode button for one second, the trip odometer can be reset to 0.
3. Total distance [TOTAL]
This is the total distance travelled by the bicycle when the electrical system has been switched on.



Settings screen





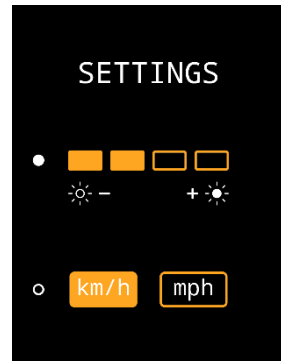

In the settings screen, the brightness of the display and the units of distance and speed can be changed.

To access the settings screen, the mode button (3) and the plus button (4) should be pressed down simultaneously for one second. Using the mode button (3), you can switch between the settings. The plus and minus buttons (4,5) are used to adjust the setting. To exit the setting screen, press and hold the mode button (3) for one second.



Notifications

Several symbols can be displayed in the information screen. The symbols are explained below. More information on the notifications can be found in the chapter **"Possible Faults"**.

-  The bicycle lights are activated
-  A Bluetooth connection is active
-  No communications with the battery
-  Reverse function of (thumb) throttle is activated
-  The temperature of the controller is too high
-  Voltage is too high
-  Fault

Pedal support power assistance

The Silent electrical system provides assistance while cycling.

Starting aid

With the starting aid, pedal assistance is activated up to a speed of 6 km/h, without having to pedal yourself. To do this, press and hold down the starting aid button (6). If the button is pressed again, the function is reactivated.

If you press the starting aid button while cycling, you will get a "boost". This boost will have the same maximum speed as the bike. The activated pedal assistance mode determines the degree of assistance of the starting aid and the "boost".

The starting aid button can be used for:

- Extra assistance when starting off (starting aid).
- Extra assistance when cycling uphill (boost).

Assistance settings

The pedal assistance level can be set using assistance settings 1, 2 and 3. The assistance settings can be changed while cycling.

1. Low level of assistance, maximum range.

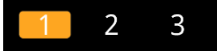

2. Average support, average range.



3. Maximum support, low range.

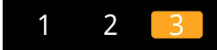

Reverse pedalling

The reverse function is activated by pedalling backwards from a stationary position. After a few turns of the wheel, the motor is activated and the bicycle will reverse at the speed of 3 km/h for as long as it is pedalled backwards.



Do not let the electric motor's sudden behaviour take you by surprise. For example, if you wait at the traffic lights and pedal backwards just for fun, the reverse function will be activated and the bike will start riding backwards!

Presets

A preset is a set of settings which sets the level of assistance. By loading a different preset, the level of assistance for all assistance settings can be adjusted. Presets can be changed by the dealer or through the Van Raam app.

Charging the Battery

For the best performance and to prolong the life of the battery, we recommend that you charge the battery at home at room temperature.



Use the charger only when the ambient temperature is between 0 and 35 degrees.

To charge the battery:

1. Unlock the battery by turning the key a quarter.
2. Pull the handle forward.
3. Take the battery pack from the holder.
4. Take the battery pack inside. **First** plug the charger into the socket. The green LED will light up. The charger is now on standby.
5. **Then** insert the connector of the charger into the charging point of the battery. The red LED will light up. The charger is now charging.



Please note! If the battery is not connected properly, the green LED will light up (standby mode). If the connection is poor, unplug the plug from the socket and clean the charger's connector with a dry cloth.

6. Depending on the battery level, the charging time is about 2,5 hours with a 13,6 Ah/36 V battery.
7. Once the battery is fully charged, the green LED will be solid. Now **first** remove the charging connector of the charger from the connector of the battery.

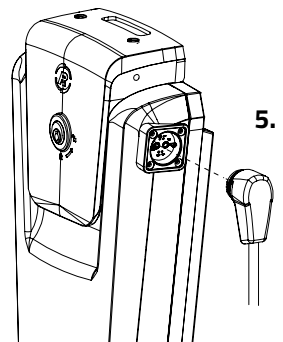
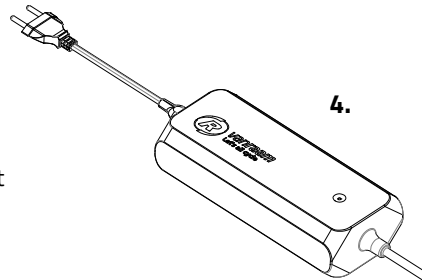
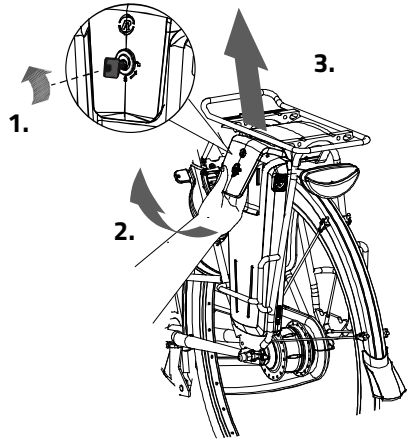

8. **Then** unplug the charger from the socket.
9. Put the battery back in the holder of the cycle. Slide it behind bar [A] and press it firmly on strip [B].

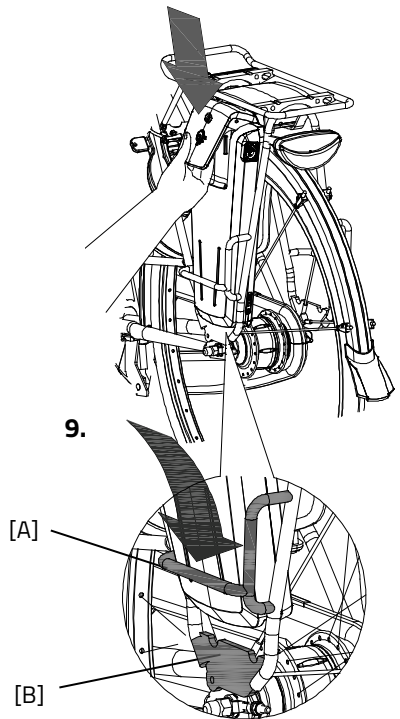

10. Pull the handle backwards and push the top of the battery to connect as shown in the drawing and close the lock.
11. Push the handle forward and close the lock.

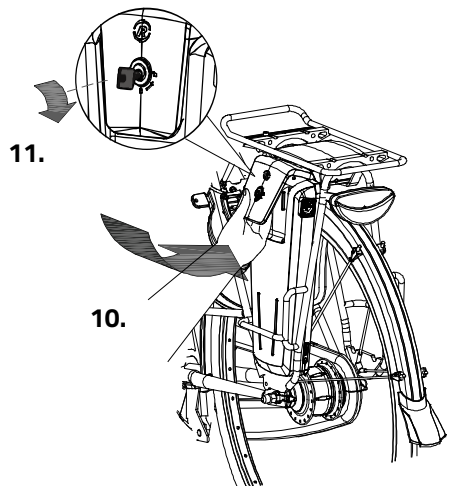

It is also possible to charge the battery while it is still in the holder.

Charger:

LED indication	Status
Green	Standby
Red	Charging
Green	Battery full
Red, blinking	Safety: Polarity inversion; Short; Over temperature; Over power; Over voltage

Charger indicator light

The status of the charger is indicated by the coloured indicator light.

- If the indicator light is green, the charger is in standby mode or the battery is full.
- If the indicator light is red then the charger is charging the battery.
- ⊘ If the indicator light flashes red then the charger is in safety mode.

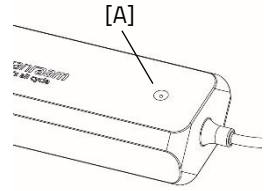

Caution! Unplug the charger from the power outlet.



Only use the charger when the ambient temperature is between 0 and 35 C.



It is better for the battery to be charged periodically instead of waiting until it is completely empty.

Battery indicator lights

On the battery pack there is an LED indicator to check the battery charge status. The battery charge status can be read by briefly pressing the on/off button [A]. While the battery is being charged, the indicator shows the charging progress:

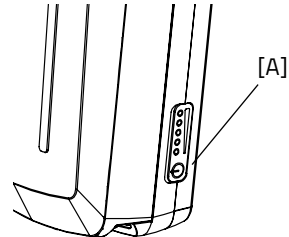

- The battery is fully charged. When the battery is used, the number of green lamps will decrease.
- If two green lamps are lit, the battery is 50% charged.
- If only the left LED remains green, the battery is almost empty and needs to be recharged or replaced with a charged battery.
- ⊘○○○○ If the left LED starts blinking green, the battery is empty and the motor will not support cycling for much longer. However, the switchable lighting will still work after that.



Never put the bike away with an empty battery.

Deep sleep battery mode

When the battery is almost empty and has not been used for a week, the battery will go into a "deep sleep mode". In this mode, the battery uses as little energy as possible, which extends the battery life.

When "deep sleep mode" is activated, the battery cannot be used. By pressing the on/off button [A] on the battery, the battery will be released from 'deep sleep mode' and can be used again. It is advisable to charge the battery before using it.

Charging and maintenance of the battery pack

Important safety warning:



Completely drain the battery during the first use. The battery will then make optimal use of its capacity. It is not necessary to drain the battery in one go; this can also be spread over several rides. After draining, fully charge the battery. The battery can then be used as needed.

- To ensure the battery's optimal condition and capacity, we recommend charging it indoors at room temperature.
- Never put the bicycle away with an empty battery. We recommend charging the battery as soon as possible when it is empty. The best storage charging level for the battery is when the charge display shows three to five LED lights.
- In winter, check the battery charge every other month, recharge it if less than three LEDs light up.
- Preferably store and use the battery between 5 and 20 C, avoid higher and lower temperatures.
- Do not charge the battery in direct sunlight and make sure that the battery is not charged at a temperature lower than 5 C.
- Only use the charger in dry indoor areas, the charger is not allowed to get wet.
- Only use the supplied Van Raam battery and charger.
- The housing of the battery and the charger must not be opened. In case of any problems, please consult your dealer.
- A Van Raam battery is not allowed nor is it possible to recondition the battery due to safety reasons and incorrect functioning of the electrical system.
- Do not drop the battery as this can cause external and internal damage.
- If the bicycle malfunctions, the battery must be disconnected from the bicycle.



Keep in mind that the bike provides less assistance at lower temperatures (0°C and below) and that the battery will drain more quickly. It also takes longer to charge at low temperatures.



Every battery drains over time. This process is called 'self-discharge'. A battery that is empty and not charged can undergo a deep discharge caused by self-discharge and become faulty as a result. The warranty is voided in the case of a deep discharge.



Keep in mind that every battery wears out over time. The wear and tear process of the battery is inevitable and depends on several factors such as use, the number of times to fully discharged and charged and the ambient temperature. Even if the battery is not used, its capacity will decrease. A worn-out battery can be used, but keep in mind that the range will be reduced.

Possible faults

- The system cannot be switched on:
 1. Check that the battery is attached properly.
 2. Check the status of the battery. If it is empty, charge the battery.
 3. If the above does not provide a solution, please contact your dealer.
- If a red LED flashes on the charger, unplug the charger from the power outlet and stop using the charger and battery. In this case, contact your dealer.

Faults table

Fault symbol/ code	Description	Consequence/ course of action
All assistance modes are flashing	Temperature controller too high	System does provide assistance, motor power is reduced.
Thermometer (symbol) + all assistance modes are flashing.	Temperature controller too high	System does not provide assistance, let the controller cool down.
Battery with cross (symbol) + all assistance modes are flashing	No communications with the battery	System does provide assistance. Contact your dealer.
Lightning bolt (symbol) + assistance settings are turned off	Voltage too high	System does not provide assistance, voltage drops automatically when cycling speed is slower than maximum assistance speed.
Exclamation mark (symbol) Exclamation mark (symbol)	Voltage too low	System does not provide assistance, check the connection between controller and battery. Check how full the battery is.
	Controller communication error	System does not provide assistance. Contact your dealer.
Active assistance mode is flashing	Electrical current too high	System does not provide assistance. Contact your dealer.
Active assistance mode is flashing	Motor sensor fault	System does provide assistance. Contact your dealer.
All assistance settings are turned off.	The battery is almost empty.	Charge the battery

Charging and maintenance of the battery pack

Important safety warning:

Charger safety precautions

- Only charge Van Raam Li-Ion batteries with the supplied charger. Only connect the charger to a suitable wall socket (220–240 Volt AC 50-60 Hz). When the charger is not in use, disconnect it from the power outlet and the power plug from the battery.
- The charger may only be used by persons who have read the information in this manual and are familiar with the correct use of the charger. Keep the charger out of reach of children; they should not play with the charger.
- The charger is designed for use in a dust-free, dry and ventilated environment. Do not expose the battery to water, heat sources and direct sunlight. Keep the charger clean and dry.
- Do not charge batteries that feel hot. The battery may only be charged in places where the temperature is no higher than room temperature. Stop charging if the battery gets hotter than ($> 40^{\circ}\text{C}$).

Caution! The charger can become warm during charging $> 50^{\circ}\text{C}$. First, carefully feel whether you can pick up the charger, this temperature can cause hypersensitivity or a startled reaction when it comes into contact with the skin.

- Do not use the charger if it is visibly damaged or modified. Do not repair the charger yourself! Please contact Van Raam. You are strictly prohibited from opening the charger yourself!
- Always keep an eye on the charger and battery while charging. When the battery is full, disconnect the power plug from power outlet and remove the power plug from the battery.

Silent Electrical System options

There are different options for the electrical system for each bicycle model.

Spare battery (optional)

The bike can be supplied with a second battery.

To activate the second battery (when the first battery is empty) turn the switch under the luggage carrier to the side of the second battery.

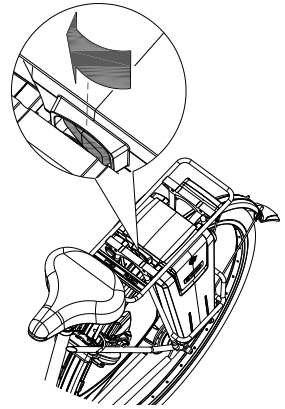

Direction Indicator

The bike can be equipped with a direction indicator. To operate the direction indicators, press switch [A] on the handlebar to the left or right. When the direction indicator is active, a clicking sound can be heard. To deactivate the direction indicator, you need to set the button to the middle position. The direction indicator is powered by the battery of the Silent Electric System.

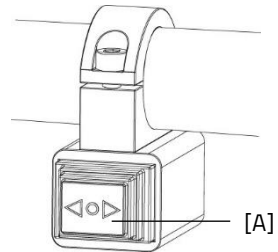

Please note that the turn signal can only be activated when the bicycle's lighting is turned on.

Van Raam e-bike app

The Van Raam bicycle app is a free smartphone app that you can use while cycling on your electric Van Raam bicycle.

Apple app store:



Google Play Store:



The Van Raam e-bike app can be downloaded free of charge from the **Google Play Store** or **Apple App Store**.

For more information about the Van Raam e-bike app, you can visit the Van Raam website: www.vanraam.com.

Accessories

Depending on your order, you can use the accessories as described below. Extra accessories are available at your dealer.

Dividable frame

The ramp can be disconnected from the bike, which can be convenient if, for example, you want to store the bike.

To disconnect the ramp:

1. Use the parking brake by pressing the left brake [A] and securing the brake with the pin [B].
2. Remove the right handle (with gears) from the handlebar. Press the spring's small sphere to remove the handle from the handlebars. Also remove the parking brake from the steerer tube by lifting it straight up from the holder (this can take some strength).
3. Hang the grip together with the brake handle on the luggage rack or other suitable parts.
4. Lower the support. By loosening knob [A], push down support [B] with your hand or foot and then fasten the knob again.

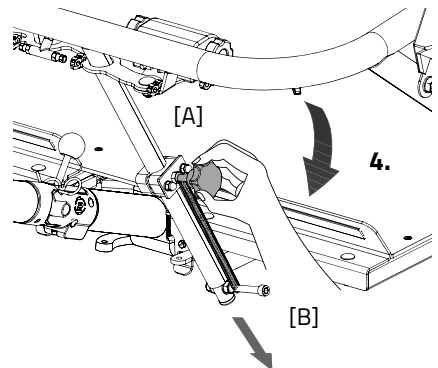
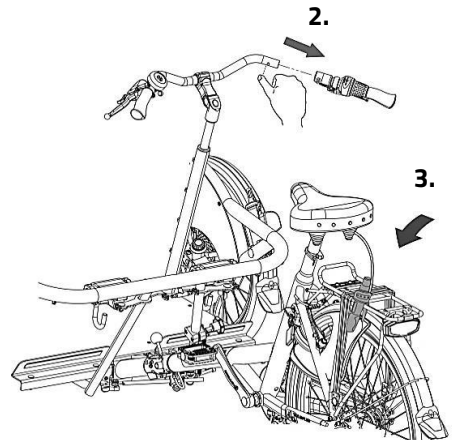
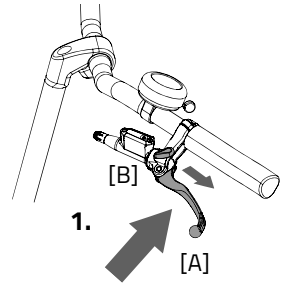

5. Remove the safety pin.
6. Hold the rear part (tricycle part) with one hand and then use your other hand to pull the lever backwards [A], allowing the tricycle to detach.

The wheelchair element will now stand on the support wheel.

7. Remove the bike apart from the coupling.

Caution: this is heavy! Hold the frame firmly in both hands.

8. Place the bike on the stand.

To reassemble the bike, follow these steps in reverse order.

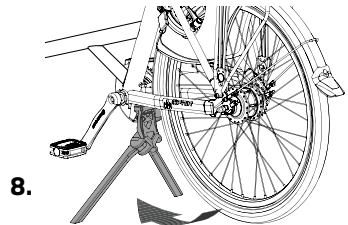
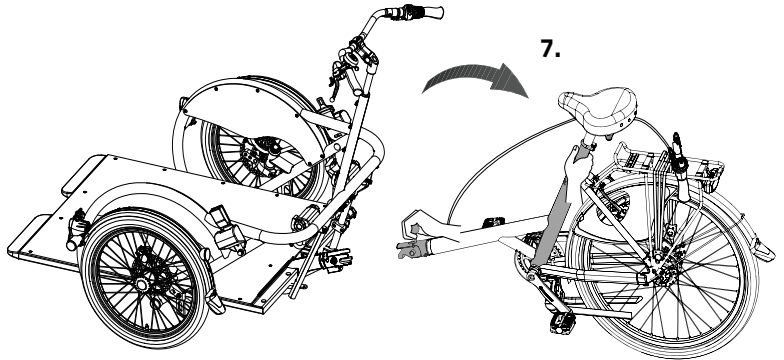
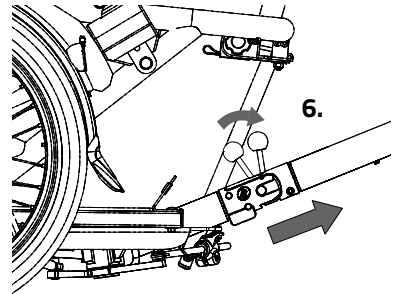
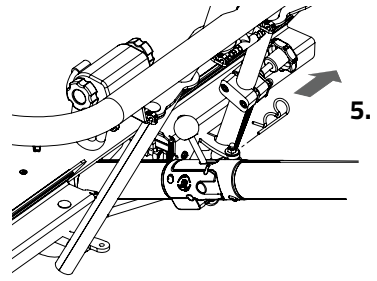

Winch system

It is possible to place the wheelchair on the bike with the help of a winch.

To use the winch system:

1. Switch on the electrical system. Make sure that the light on the control panel is on. If this is not the case, you can switch on the winch system by briefly pressing the on/off button on the display of the electrical system.
2. Put the bicycle on the parking brake by squeezing the left brake [A] and securing it with the lever [B].
3. Remove the safety pin.
4. Pull the handle upwards so that the ramp unlocks and falls down.

1.

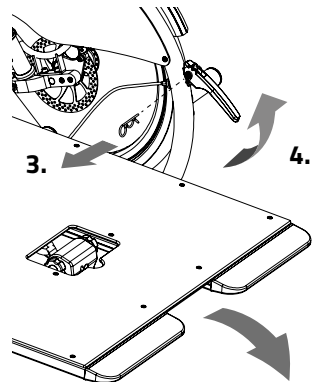
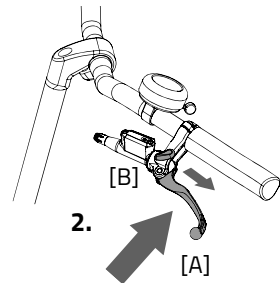
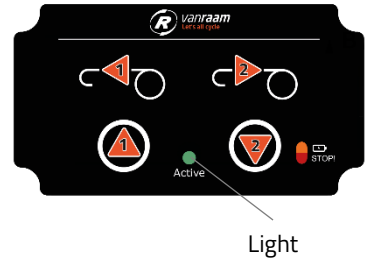

- Use the control panel on the bicycle or the remote control to unwind the winch. Press and hold the button and at the same time guide the winch so that it unwinds correctly.

Attention! Do not roll out the winch beyond the **red line** on the belt, otherwise the belt will roll back on incorrectly.

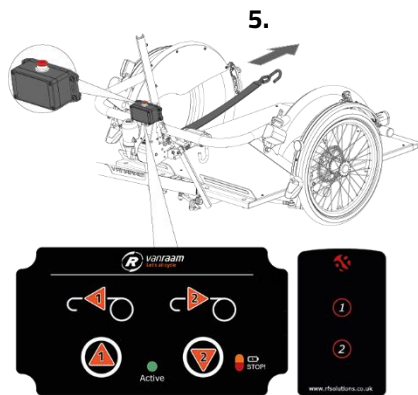

Control panel on bike Remote control

- Place the wheelchair **straight** in front of the ramp and secure the hook to the wheelchair.

Attention! Place the hook as close to the ground and in the middle of the wheelchair as possible to prevent the wheelchair from tilting and twisting.

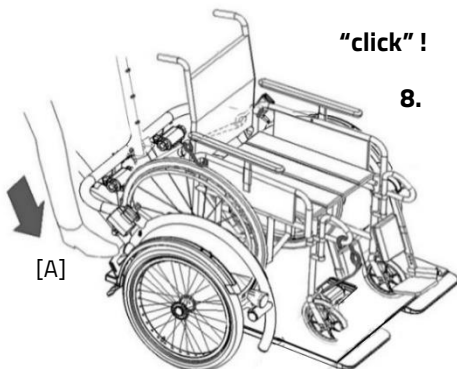

- Use the control panel to rewind the winch. Hold down the button and at the same time guide the wheelchair so that it is positioned straight onto the ramp.
- Pull the wheelchair onto the ramp until the ramp tilts and locks automatically and you hear an audible click.

Attention! Make sure that the ramp locks into place! Otherwise very dangerous situations may arise. If the ramp does not engage, press with the foot [A] so that the ramp engages.





Make sure that as soon as the wheelchair is placed on the ramp, the weight of the wheelchair automatically causes the ramp to fold up. At this moment the centre of gravity of the wheelchair lies above the front wheels of the bicycle. This ensures the correct weight distribution of the bicycle.



Only place the wheelchair forwards, in the direction of travel, on the ramp. (see picture)



The winch hook is not meant to fix the wheelchair on the bike.

9. To further secure the wheelchair, follow the steps described under the heading 'setting up the bicycle - wheelchair transport'.

To remove the wheelchair from the bicycle, follow these steps in reverse order.



Hold the wheelchair when you release the hooks so that the wheelchair does not drift off the ramp.

The control panel on the bike and the remote control are interconnected. When the battery light on the control panel is on continuously, the winch system is activated and the remote control (Remote Control, RC) is charged. When it starts flashing, the battery of the remote control is almost empty and needs to be replaced.

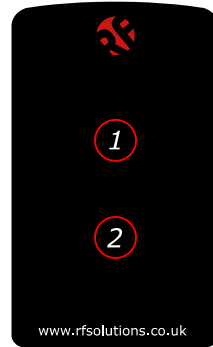
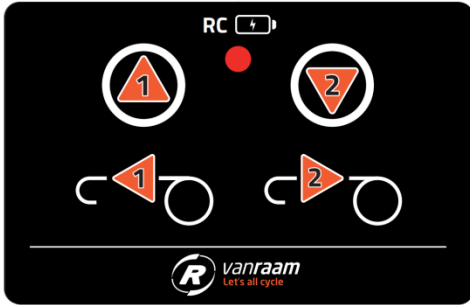

Follow the next steps to replace the remote-control battery.

1. Remove the cover on the back by unscrewing the two screws.
2. Replace the battery (CR2032, 3V), note position +/-, and mount the cover.



Batteries are polluting to the environment. When disposing of batteries, follow local regulations.

Remote control

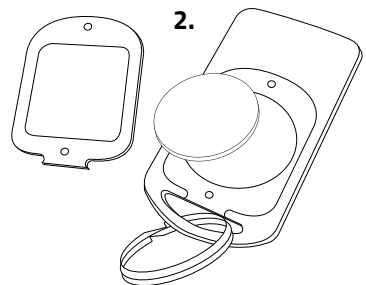
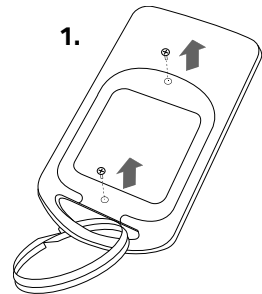

Technical specifications

Length (cm)	253
Width (cm)	110
Height (cm)	114
Boarding height (cm)	28
Length of inner leg (cm)	80 - 95
Front wheel	20"
Back wheel	26"
Weight (kg)	approx 64
Max. load luggage rack (kg)	20
Max. weight rider (kg)	110
Max. weight passenger incl. wheelchair (kg)	140 ¹ , 200
Brakes, front	Disc brakes
Brakes, back	Cantilever brakes

¹ Standard

Maintenance and adjustments to be done by owner

Below you can find the instructions for maintenance and adjustments that you can do yourself on a regular basis, which will keep your tricycle in top condition.

Cleaning

The frame of the tricycle can be cleaned with a damp cloth. For areas that are dirtier you can use a mild detergent.

The wheels can be cleaned with a moist brush with plastic hairs (not a wire brush!). The saddle and the grips can be cleaned with mild soap and water.



Do not use a pressure washer or a steam cleaner!

The right lubricant

The chain should be cleaned and maintained at regular intervals (every three months approximately). Only use special chain grease or Tevlon spray. This is the only way to make sure that the chain will run smoothly, will stay water resistant and will not rust.

1. Wipe the chain with a cloth.
2. Treat it with grease or spray.
3. Remove any excess lubricant with a rag.

Other parts should **not** be treated with a lubricant.

Inspection of the tricycle

It is recommended that the tricycle has a yearly inspection carried out by the dealer to claim warranty. Please use the form "Form service, maintenance, modifications and warranty claims" in the back of this manual. After 200 kilometres or after a period of two months the tricycle should be inspected.

In the event of technical trouble or faults, the tricycle should be taken to the dealer for repairs **immediately**.

The replacing of safety-related components (especially frame, brakes, lighting, handlebars, front fork and actuation) should be performed by the dealer.

If you still decide you want to replace components yourself, you are responsible for damage or harm due to incorrectly fitted components.

Only use **original** Van Raam spare parts, which you can buy at you dealer. If requested the dealer will make the necessary information on repair and maintenance available.

Repairs and maintenance to be done by dealer

Check the brakes, the rims, lighting, the chain tension and the spokes. Also checks the tyre tread depth. This should be at least one millimetre. Worn out tyres or possible faulty parts should be replaced. Also check the parking brake. With the parking brake pulled up, the tricycle should not ride away with the cyclist.

Checking the rim

Due to the combined action of the brake and the rims, not only the brake lining but also the condition of the rim is important. For this reason the rim should be checked at regular intervals, for example when you inflate the tyres. The presence of fine cracks in the spoke punches or deformation of the rim when there is higher air pressure indicate more serious wear and tear. In that case the rim should be replaced, because it can lead to loss of brake function or even a crack in the rim, which can lead to all kinds of dangerous consequences.

Repairs, maintenance and modifications should only be performed with original Van Raam parts.

Adjustments by dealer

The correct tension of the chains

Several chains are present on the tricycle. These must have enough room for movement. Without any real effort, the chain must be able to be moved about half a centimetre up and down.

In order to keep tension on the chain, the rear wheel axis can be adjusted. Follow the instructions below:

1. Slightly loosen the nuts on the rear wheel axis, allowing the rear wheel to move back and forth.
2. Tighten the screws on the two chain tensioners, making the rear wheel move backwards and tightening the chain. Do this in such a way that the chain has some room to move, as previously indicated.
3. At the same time, make sure the wheel is straight and located in the middle of the frame. Not to the left or right. See figure [A].
4. Lightly tighten the nuts of the rear wheel axis.
5. Make sure the tension on the chain is adequate and that the wheel is attached straight to the frame.
6. Now firmly tighten the nuts.

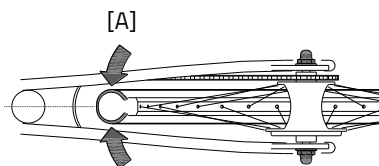
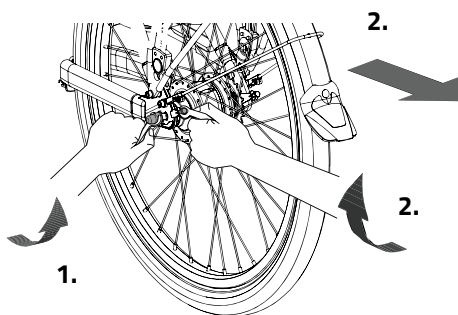

Disposal

If you want to dispose your tricycle, contact your dealer. You can also contact the local waste disposal company. They will dispose the tricycle according to the regulations of your town.

Recycling the Battery

If your battery is defective or if you are no longer using it, you must have it recycled. Please contact your dealer. They are responsible for complying with the recycling obligation. Ask them about the conditions or view the rules regarding recycling in your place of residence/country.

Handover/sale to a new owner

When you hand over your tricycle to a new owner it is important that you also hand over all necessary technical documentation and spare keys, so that the new owner can use the tricycle safely.

Do you use the Van Raam E-Bike App and have you linked your bike and battery to the app? Make sure you disconnect the bike and battery from the app when transferring/selling.

Guarantee

The guarantee is valid for all faults in the product, which are proven to be caused by material or manufacturing error.

We give a guarantee of five years on the frame and the front fork. For all accessories and other parts (except wear parts) we provide a two year guarantee, as legally regulated. The guarantee only applies for normal use and maintenance of the tricycle, as described in this manual.

Beware!

The guarantee as well as the product liability in general expires if the instructions stated in this manual are not followed. This is also the case if unauthorized maintenance is carried out or if technical changes or additions are made with non-original Van Raam parts without permission of Van Raam. The original CE certification will become nul-and-void if modifications are done by third parties. The absence of the certification can lead to problems in insuring your bike, and for any loss or incurred.

Frame number

The frame number is printed on the sticker. This sticker is located on the frame, see the image below.

Example sticker:



Position of sticker:



Behind the seat tube

Maintenance recommendation

A Van Raam bike often is subject to extensive use and must perform in all weather conditions. By correctly maintaining the bike, the lifecycle can be extended greatly. This maintenance can be done by a Van Raam dealer. In most cases, you can do the monthly and annual inspection yourself.

Maintenance Overview:

What	One-person bike	Multi-person bike	Duration	By whom?
1 st service moment	3 months/300 km	3 months/200 km	15 min	Dealer
2 nd Service moment	6 months/1.000 km	6 months/500 km	15-30 min	Dealer
3 rd Service moment	12 months/2.000 km	12 months/1.000 km	30-90 min	Dealer
Monthly inspection*	Every month	Every month	15 min	User
Annual inspection*	Every 12 months	Every 12 months	60 min	User

* This is advised to extend your bike's lifecycle. You can also have this done by your dealer.

Monthly inspection	Annual inspection
15 minutes Among them: <ul style="list-style-type: none">• Check and inflate the tyres• Check the chain tension and grease if needed• Tighten bolts/nuts where needed• Check all lights• Check the brakes• Check all rotating parts and grease if needed• Clean the bike	60 minutes Among them: <ul style="list-style-type: none">• Check and touch up the paintwork• Check wheels for damage to rim, tire, spokes, hub and bearings• Check spoke tension and wheel trueness• Check the steering ball joints• Check all lights• Check the saddle clamp• Check the placement of all electric components (E-Bikes only)

1st Service moment

15-30 minutes

Among them:

- Check tyres and inflate
- Check the spoke tension
- Check the chain tension and grease
- Tighten any bolts and nuts if needed
- Check all brake cables and brake calipers
- Check the gears
- Check and grease all rotating parts
- Check all lights
- Clean the bike

2nd Service moment

30-90 minutes

Among them: All points from service moment 1, and:

- Checking the pedals and bottom bracket
- Checking and lubricating the lock
- Disassembling, assembling, and greasing the steering stem
- Check the steering ball joints
- Run all tests in the dealer tool (E-Bike)

3rd Service moment

60-120 minutes

Among them: All points from service moment 1, 2, and:

- Inspection of the paintwork
- Inspection of the frame/front fork
- Inspection of the seat cushions
- Inspect the functioning and sound of the motor/gear hub
- check reflectors for any damage
- Check all electric components on their placement (E-Bike)
- Run all tests in the dealer tool (E-Bike)

Service plan

1st Service moment

- Yes/No
- Dealer:
- Mechanic:

Date:

Remarks:

.....

.....

.....

.....

2nd Service moment

- Yes/No
- Dealer:
- Mechanic:

Date:

Remarks:

.....

.....

.....

.....

3rd Service moment

- Yes/No
- Dealer:
- Mechanic:

Date:

Remarks:

.....

.....

.....

.....

Annual inspection

Date	Dealer	Mechanic	Remarks

Here you have space to take notes or write down the maintenance on your bike:

Here you have space to take notes or write down the maintenance on your bike:

Here you have space to take notes or write down the maintenance on your bike:

Delivery and service form

Congratulations on your purchase of your Van Raam tricycle. This bike is produced with utmost care. To guarantee the quality as much as possible Van Raam produces the cycles according to the ISO 9001:2015 quality standards. Van Raam has been certified by DNV GL Business Assurance BV.

You will especially enjoy your Van Raam bike when the bike is adjusted to your specifications and when the instructions in the user manual are followed. Pay special attention on the service intervals who specified in the manual of the bike.

To claim warranty and service you should always fill out this form, at least at delivery and service. This signed form declares that the end user had an instruction on the operation of the tricycle, that the tricycle is adjusted to the specifications of the end user and that the user manual is received.

Fill out when the tricycle is delivered

Type Van Raam tricycle:	
Frame number:	
Key number:	
Delivered to:	
By dealer:	
Place:	
Date:	
Signature user bike:	Signature dealer:
When available, stamp dealer:	